

Limit Management System (LMS)



Top of Excellence

Themen bewegen



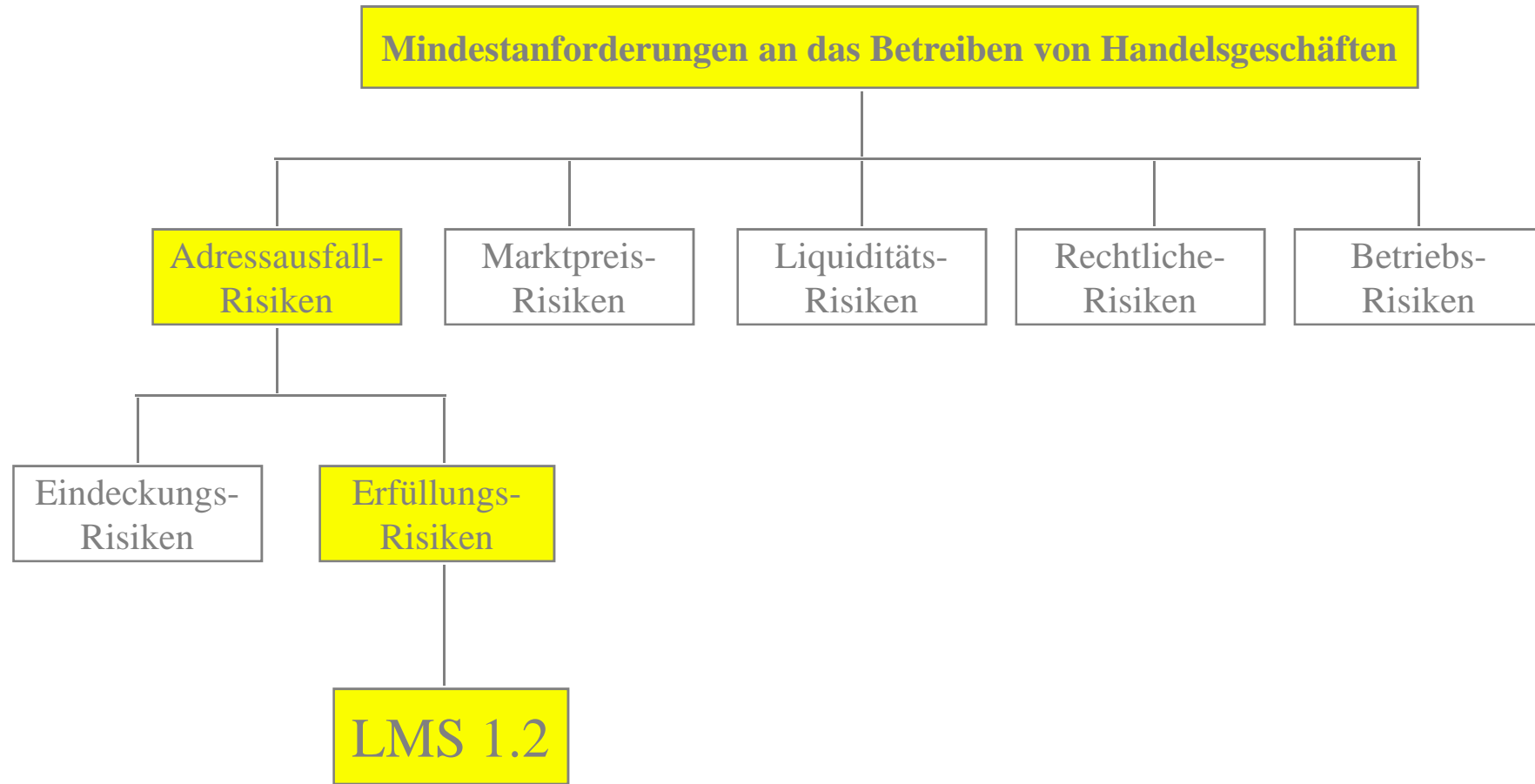

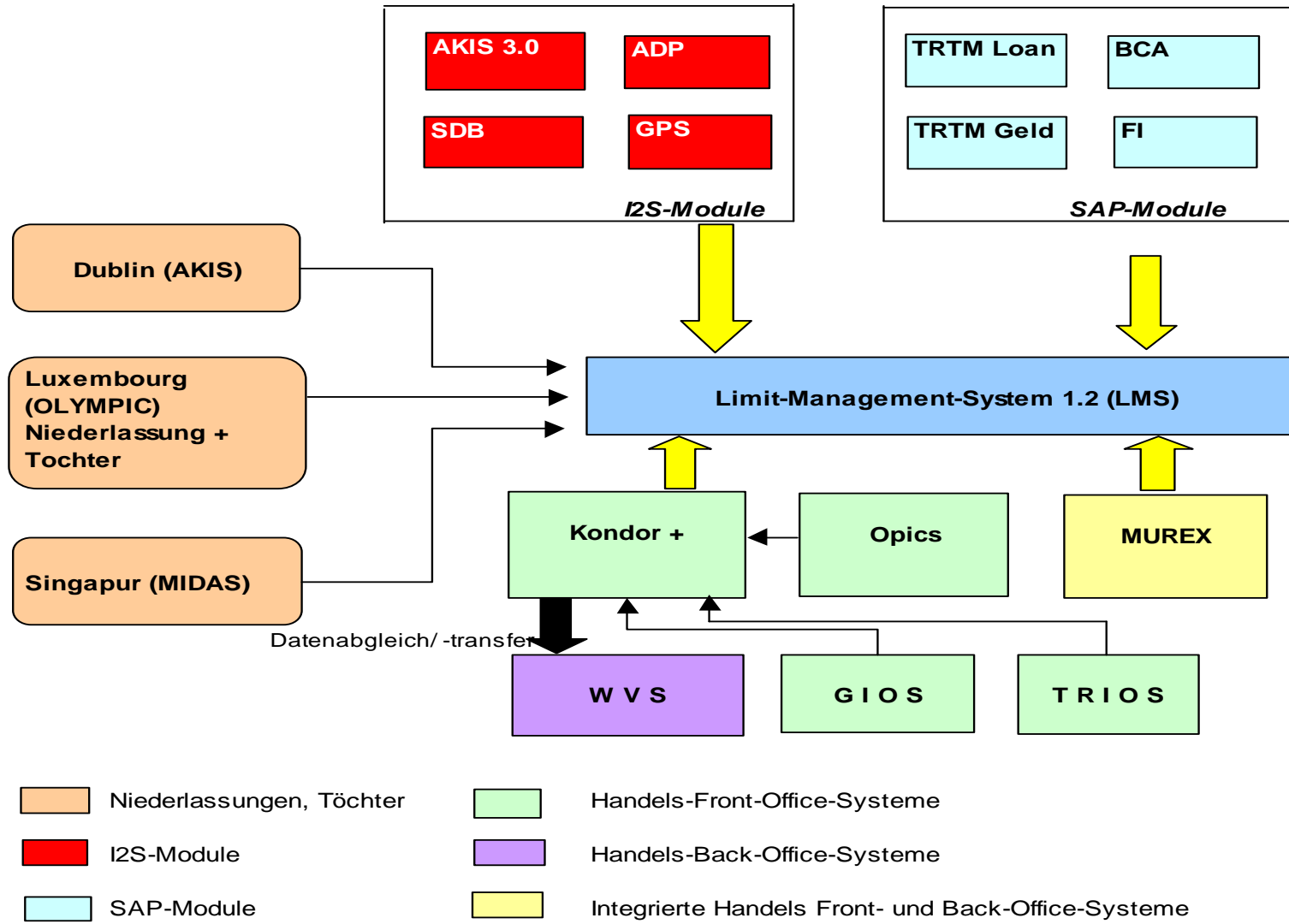



Schnittstellen -> Produktarten

- AKIS 3.0 (Auslandskredite)
- ADP (Aktienderivate)
- SDB (Sicherheiten)
- GPS (Geschäftspartner und Konzernbeziehungen)
- TRTM Loan (Inlandskredite und Kredite an Corporates)
- TRTM Geld (Geldhandelsgeschäfte)
- BCA (Kontokorrentsalden)
- FI (Beteiligungen)
- Kondor + (Wertpapiere)
- FED (Devisenhandelsgeschäfte)
- MUREX (Zinsderivate)





**Anrechnungs-
beträge**

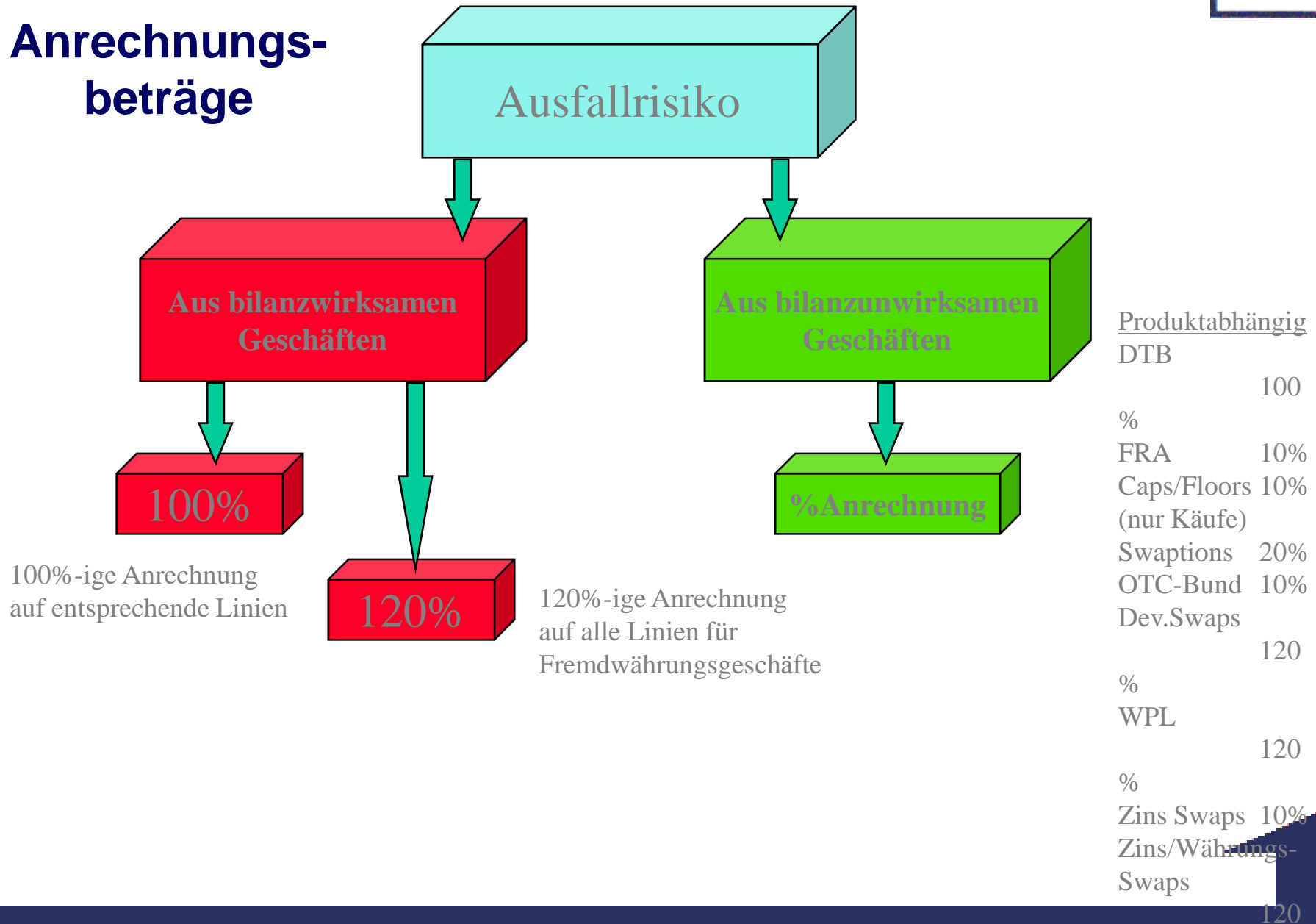

Aufbau der Limithierarchie in LMS

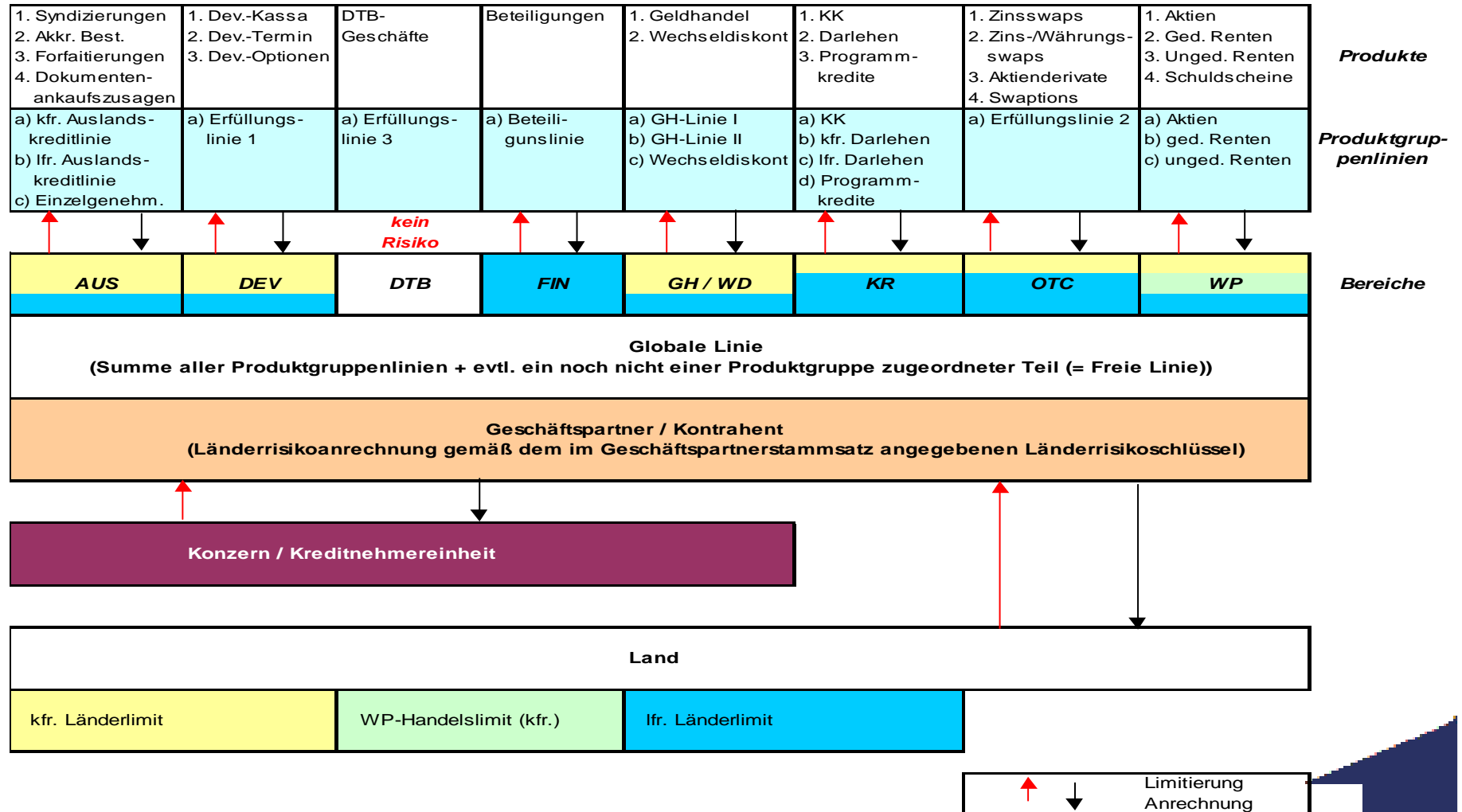

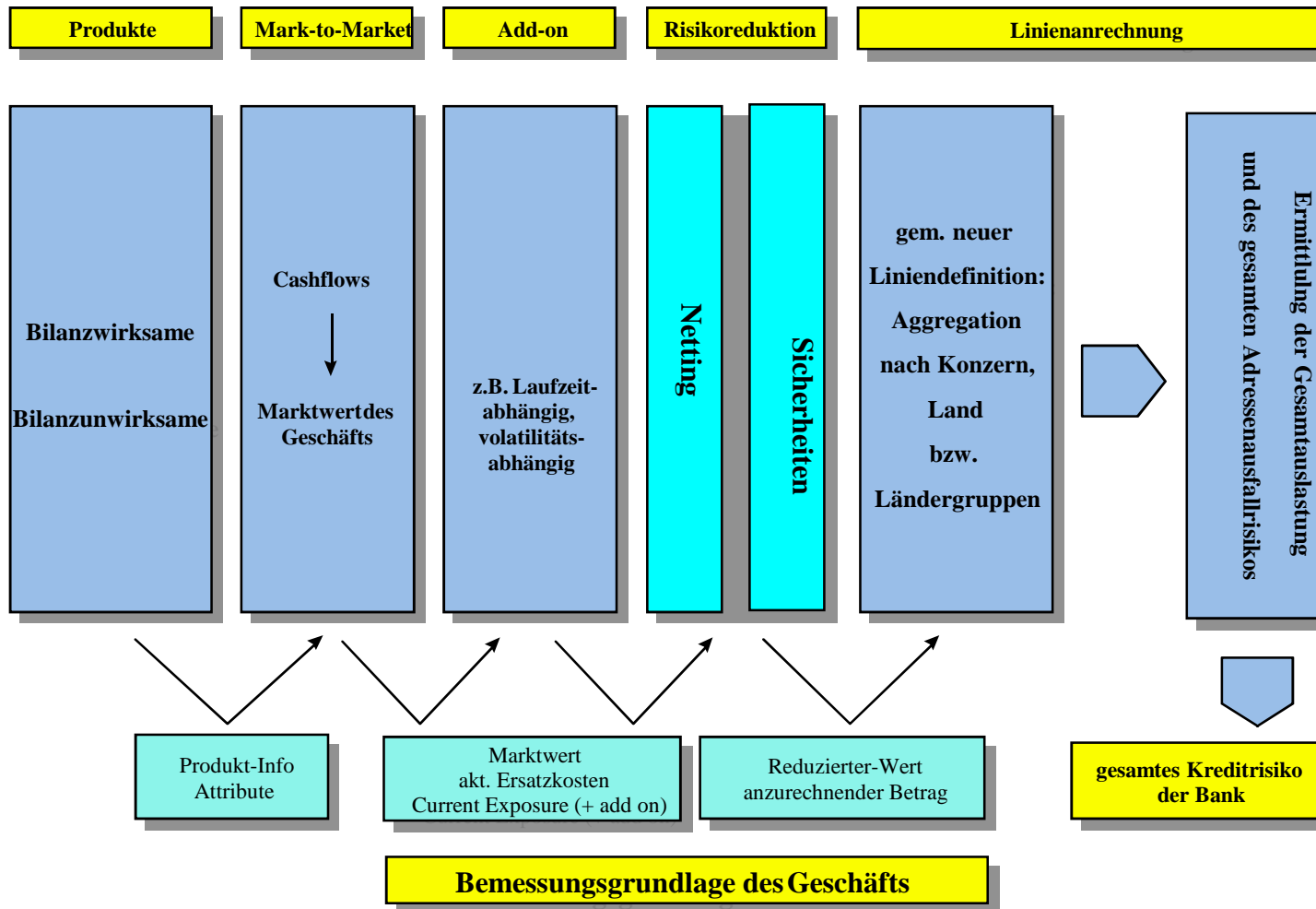

Adressausfallrisiken

Inanspruchnahme

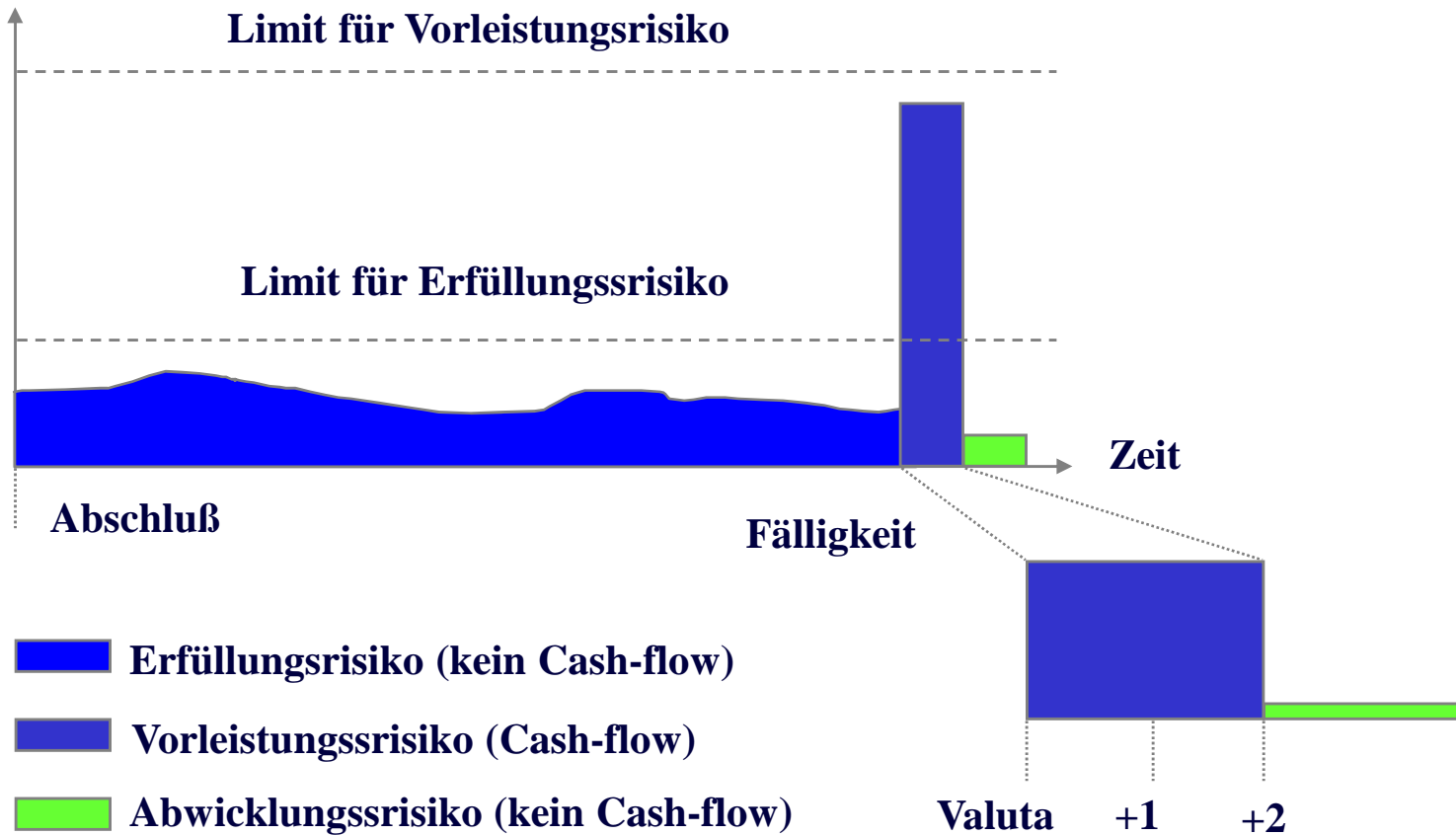

KLUGE + PARTNER

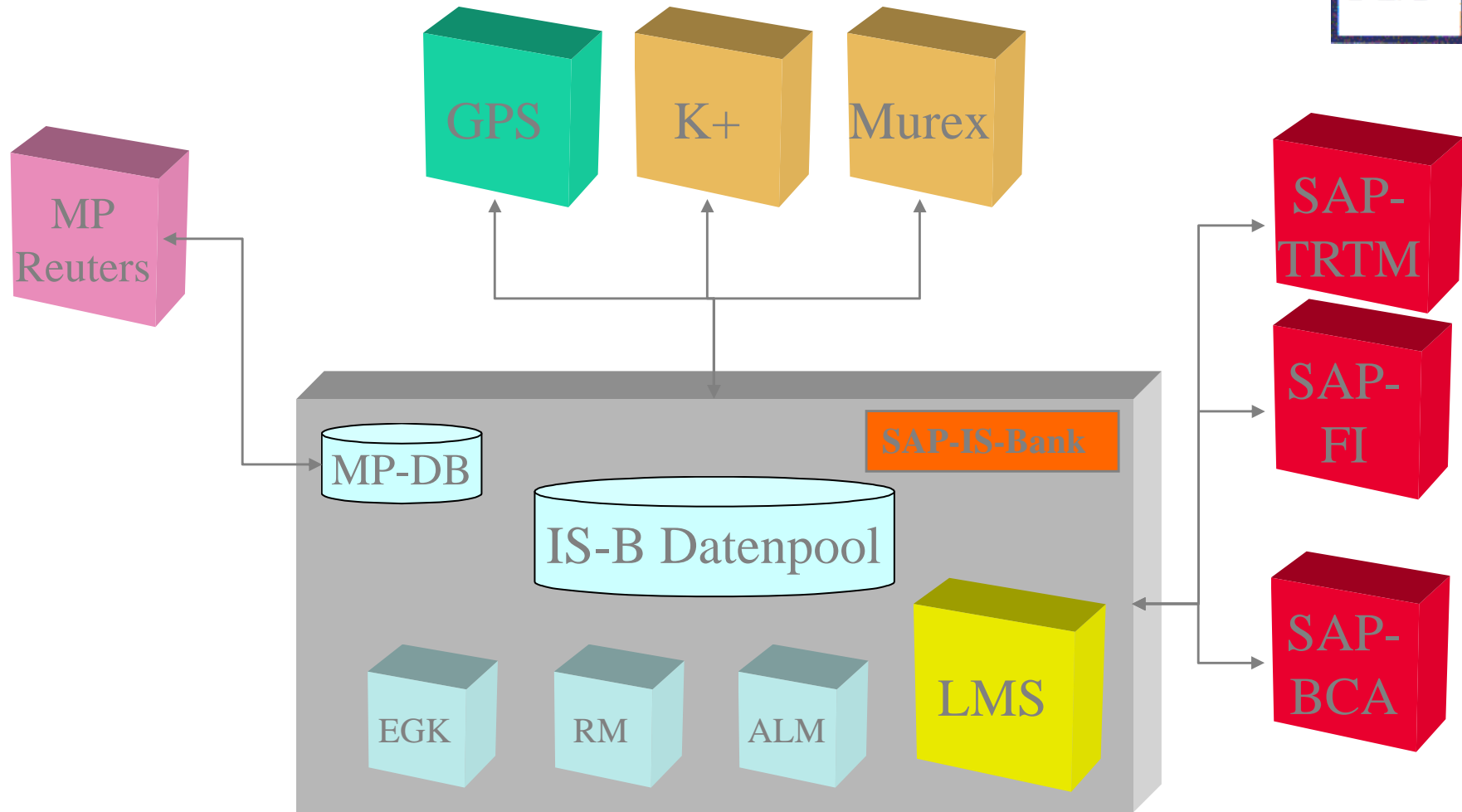

Schnittstellen

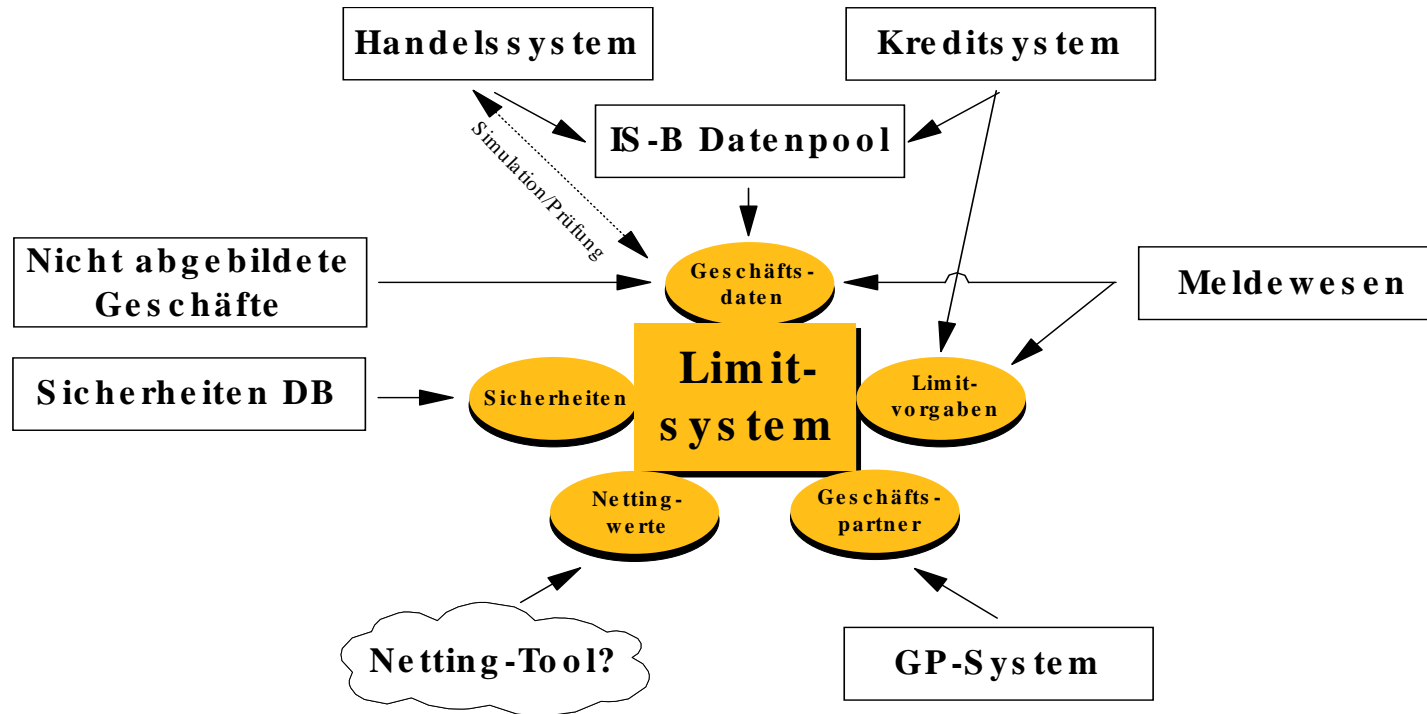

KLUGE + PARTNER

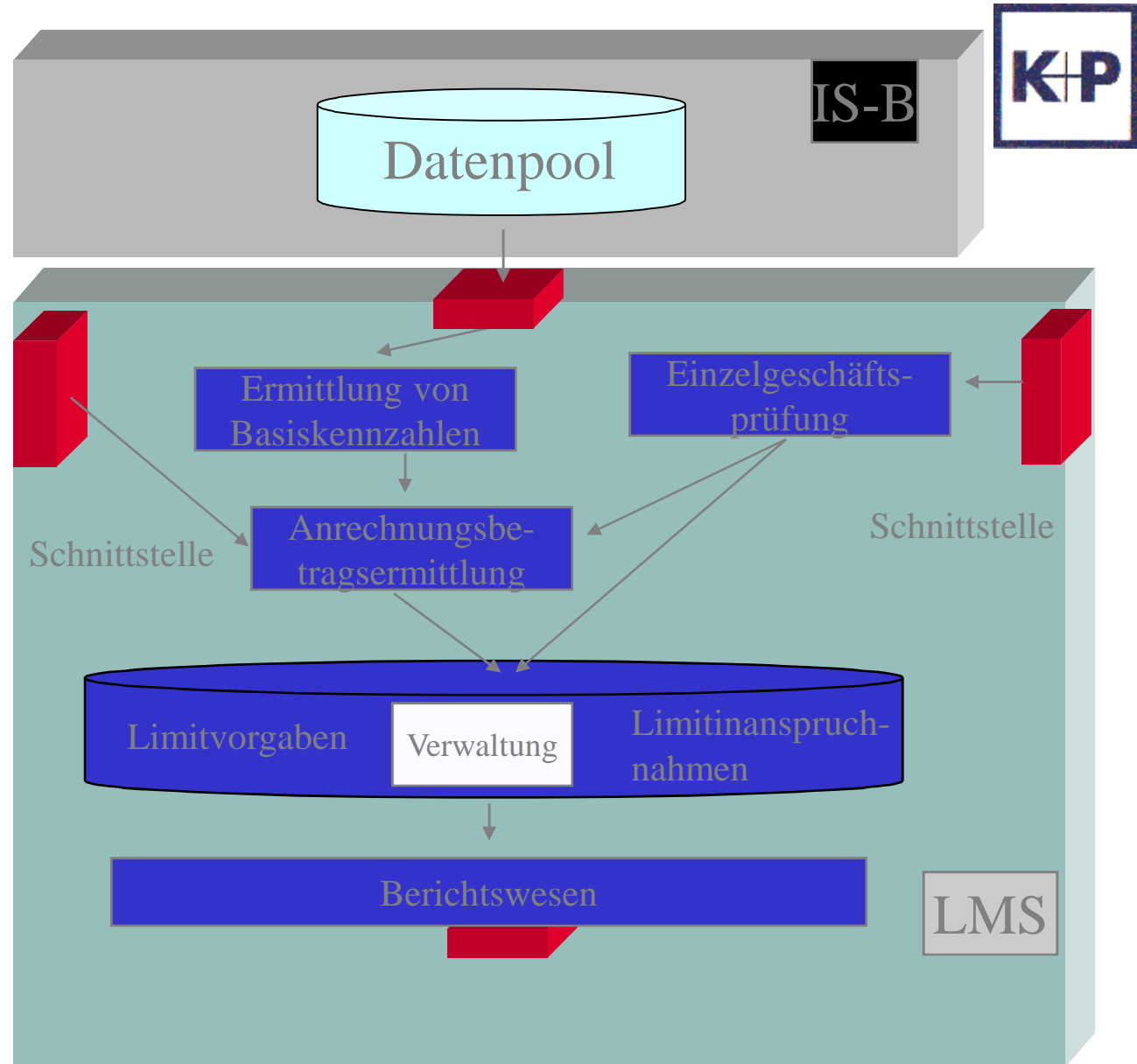

Zuordnung

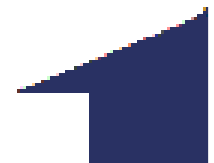
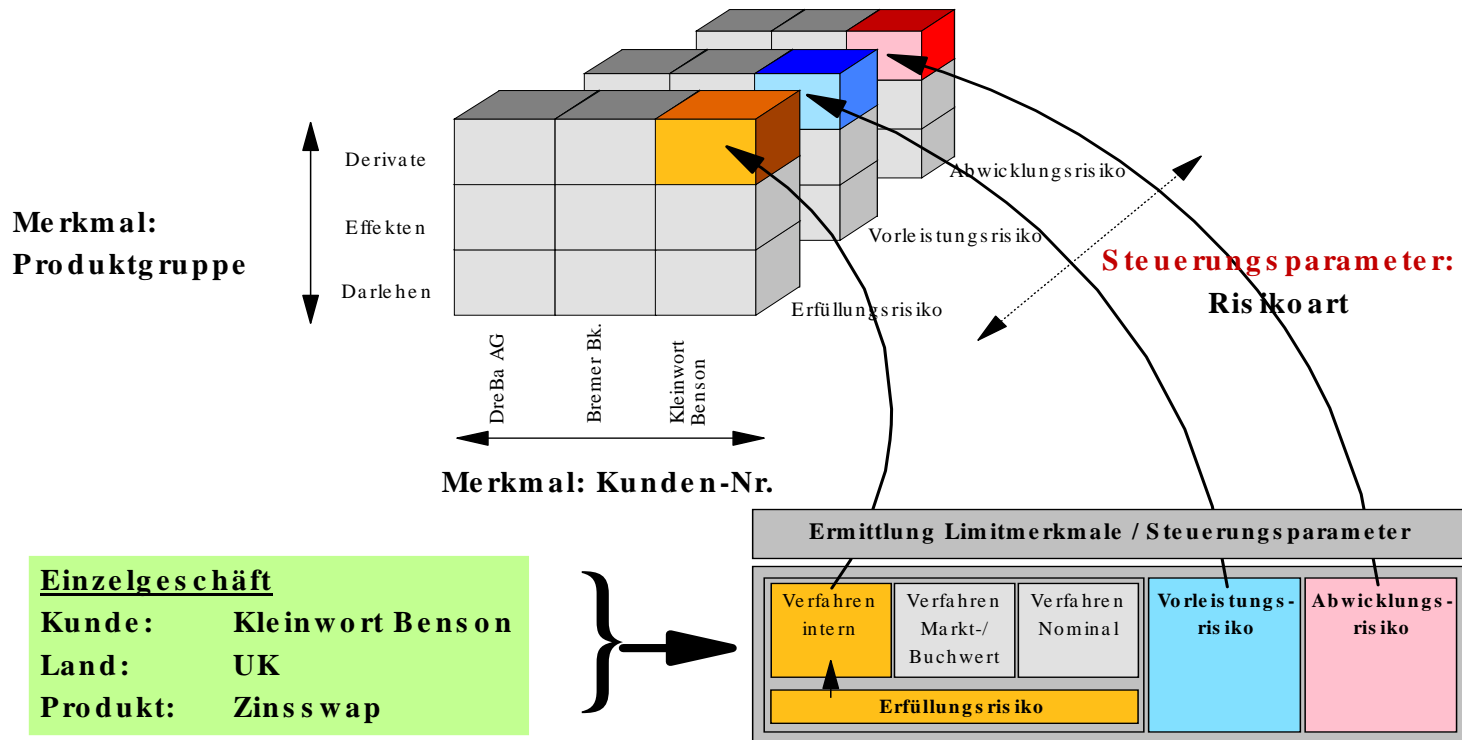

Länderrisiko

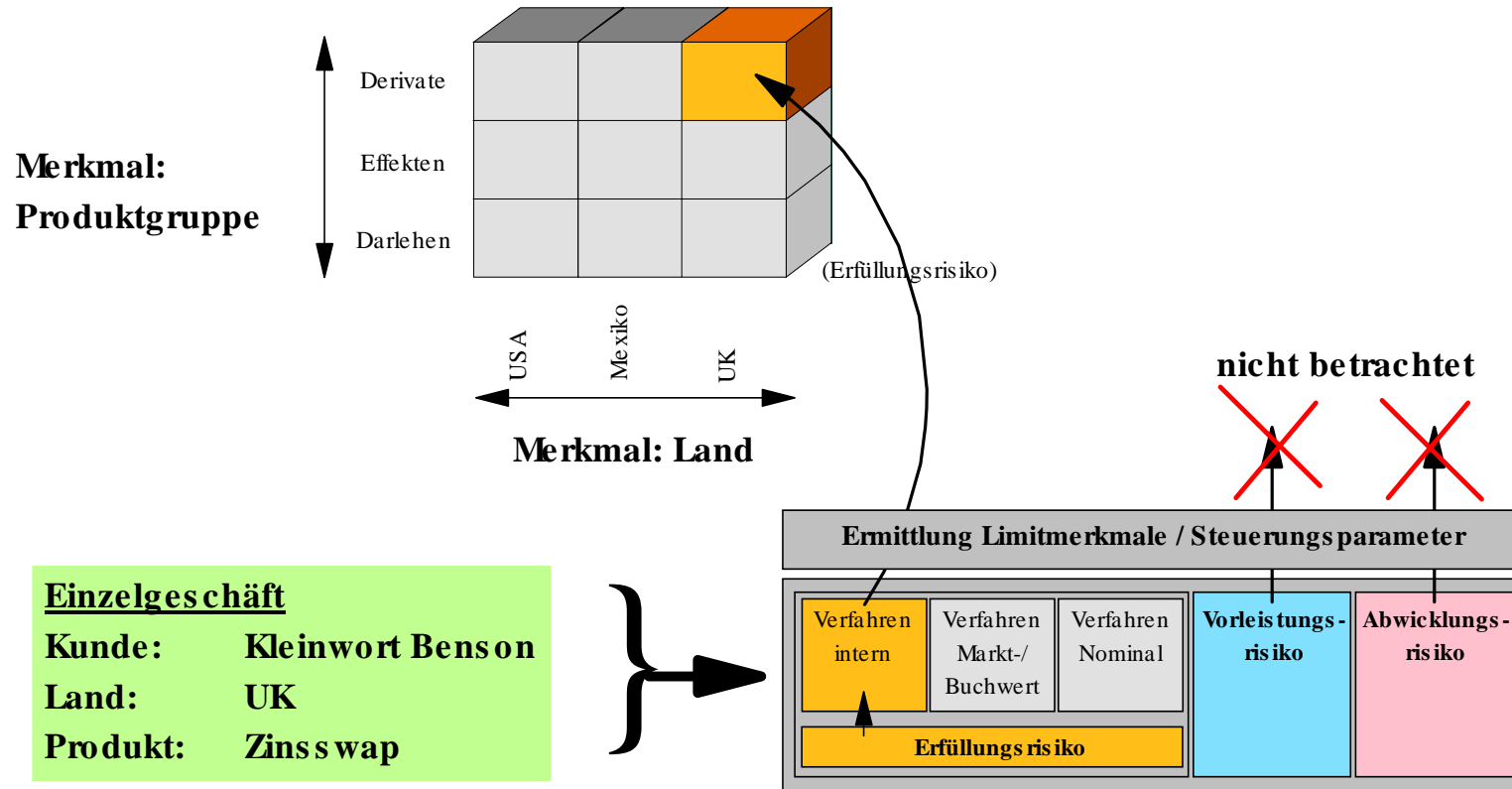

Einzelgeschäftsprüfung

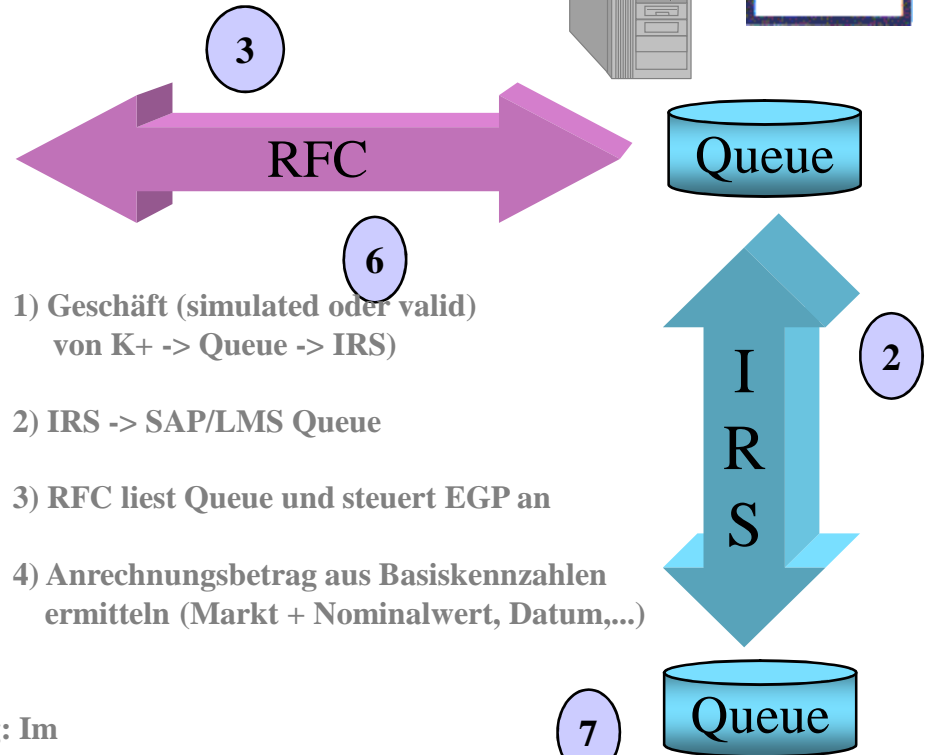
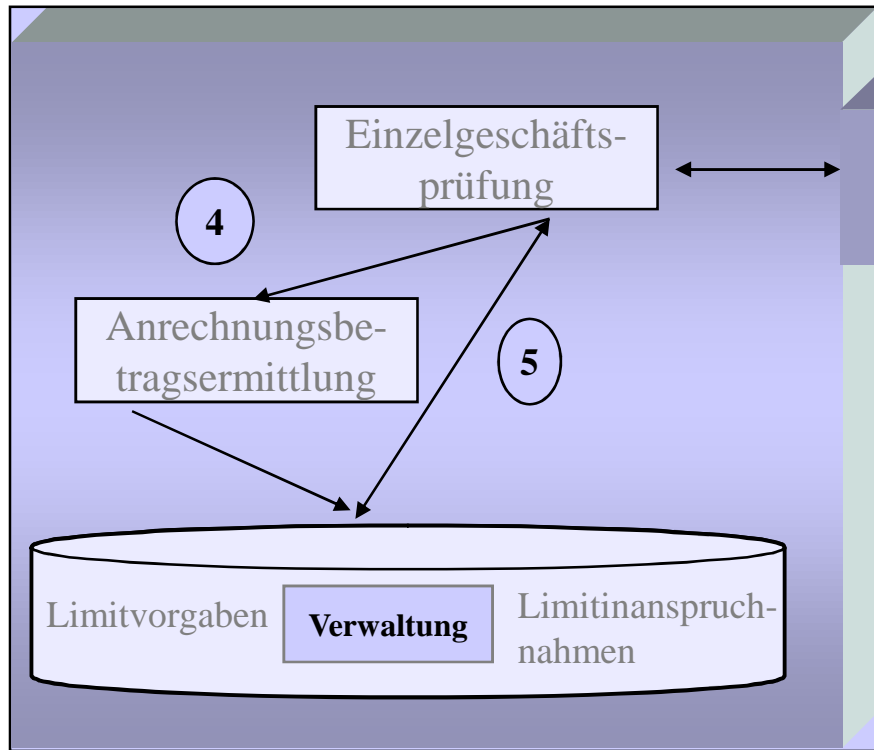

- 1) Geschäft (simulated oder valid) von K+ -> Queue -> IRS
- 2) IRS -> SAP/LMS Queue
- 3) RFC liest Queue und steuert EGP an
- 4) Anrechnungsbetrag aus Basiskennzahlen ermitteln (Markt + Nominalwert, Datum,...)

5) Prüfung/Anrechnung -> Rückmeldung: Im Limit Ja/Nein, Zahlen

6) LMS -> RFC-> Queue -> IRS

7) IRS ->Queue -> K+, Pop-up Meldung

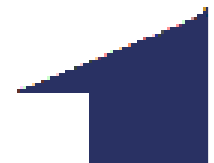

Berechnung Anrechnungsbetrag

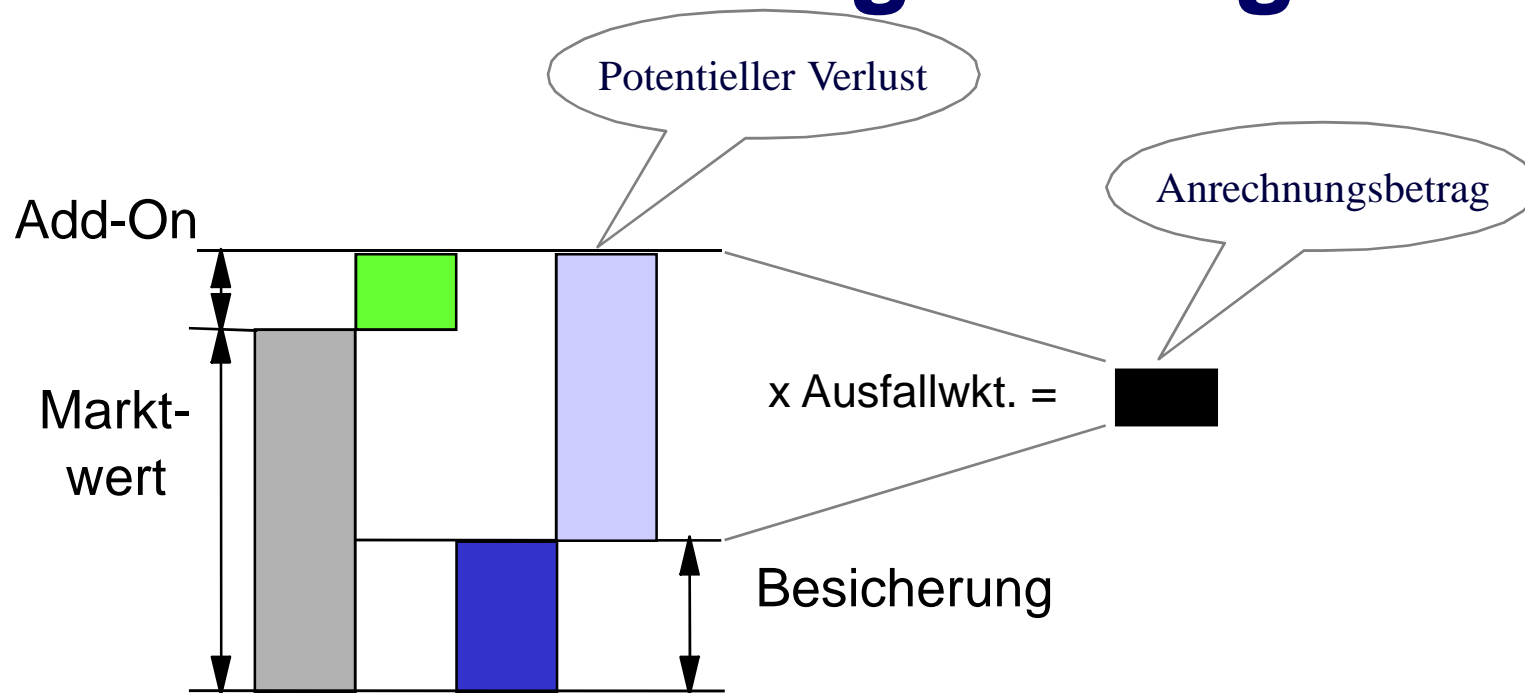



Unser know-how für Ihren Erfolg

Softwareentwicklung
Consulting

Training

One to one
Integration

CRM

KLUGE+PARTNER

K+P Consulting GmbH
info@kluge-partner.de
www.kluge-partner.de

